

# Dynamic spectrum sharing with other networks using optimized PHY/MAC layers

---

GARY CHURAN, SANTANU DUTTA AND DUNMIN ZHENG, OCTOBER 29, 2019, VERSION 1.0

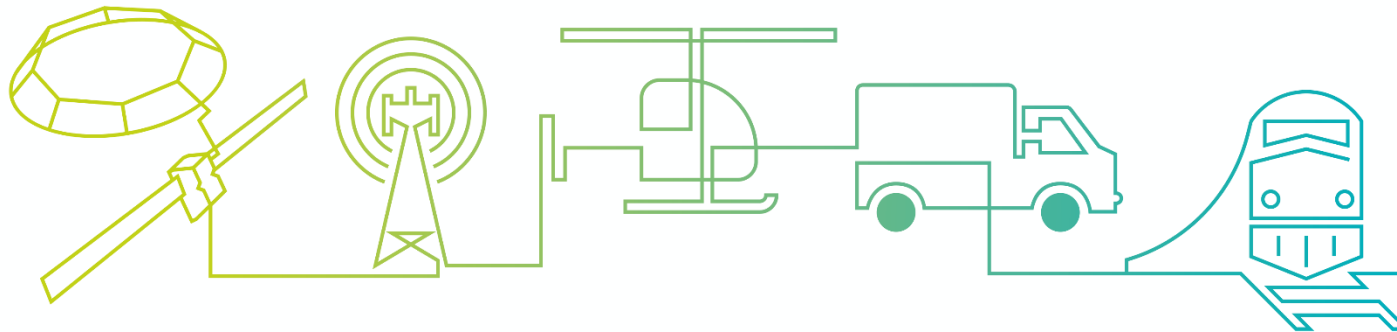

## Agenda

---

- Problem Statement
- Potential Applications of CDMA-IA
- Key Features
- Concept of Operations (CONOPS)
- Transmitter Block Diagram
- Receiver Block Diagram
- Simulations
- Potential for enhancement via AI
- Summary & Conclusions
- Backup (detailed description)

## Problem Statement

- Use Case

- Several independent services share a common wideband channel
- The services have different access priorities
- The lowest priority service can *autonomously sense the spectrum occupancy of the shared band and adaptively utilize unused segments.*

- Examples of potential applications

- HF, CBRS-GAA

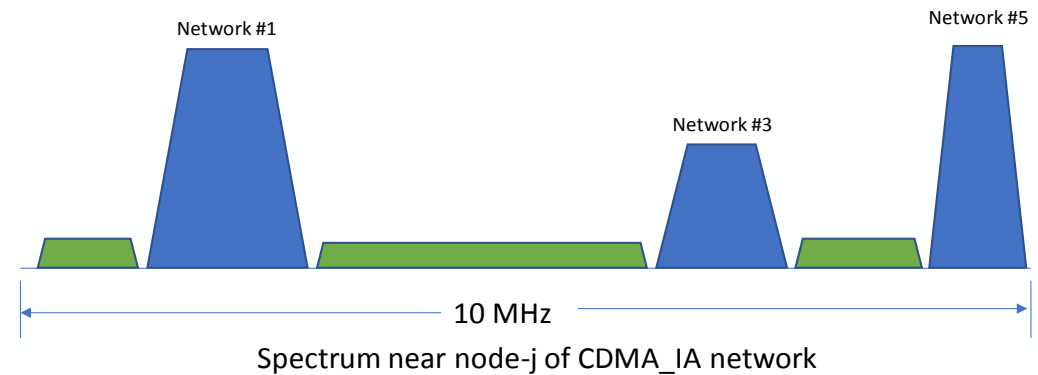
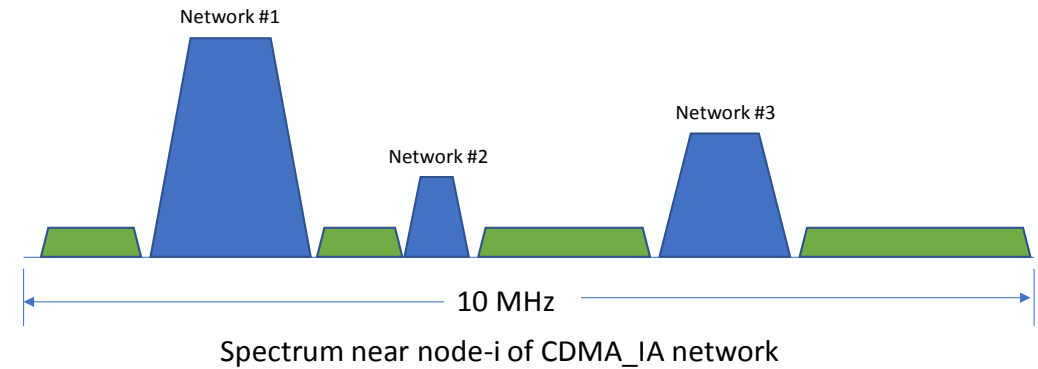

**Spectrum sharing in CDMA\_IA  
(CDMA-IA spectrum shown as green)**

## Potential Applications for CDMA-IA: (1) HF

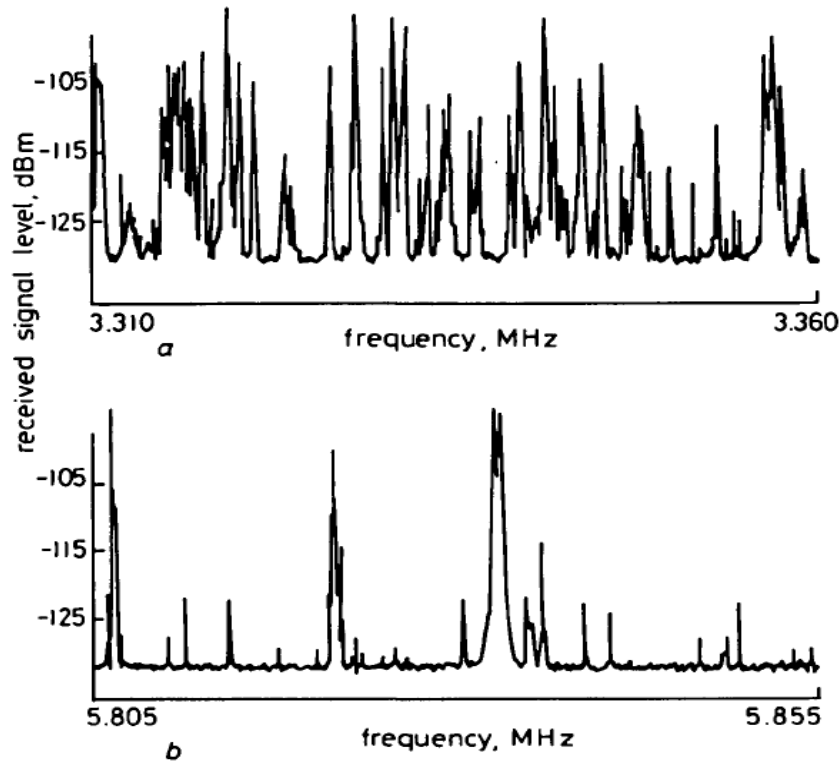

**Fig. 2** Examples of 50 kHz spectra

Resolution bandwidth = 100 Hz

OWF for 1000 km range

*a* Midnight: Congestion = 0.58

*b* Midday: Congestion = 0.17

### Characteristics of HF Interference [1], [2]

- HF interference spectrum occupancy changes from High at midnight to Low at midday
- At midnight, the spectrum occupancy is often close to 100% when examined through a 3-kHz bandwidth filter but 50% when observed through a 100-Hz bandwidth filter
- HF spectrum occupancy often remains constant over more than 30 minutes and hundreds of kms

[1] Gott, G. F., Dutta, S., Doany, P., "Analysis of HF interference with application to digital communications", IEE Proceedings, Vol. 130, Pt. F, No. 5, AUGUST 1983

[2] Dutta, S., and Gott, G. F., "Correlation of HF interference spectra with range," IEE Proceedings, Vol. 128, Pt. F, No. 4, AUGUST 1981

**CDMA-IA could substantially improve utilization of the HF band**

## Potential Applications for CDMA-IA: (2) CBRS-GAA

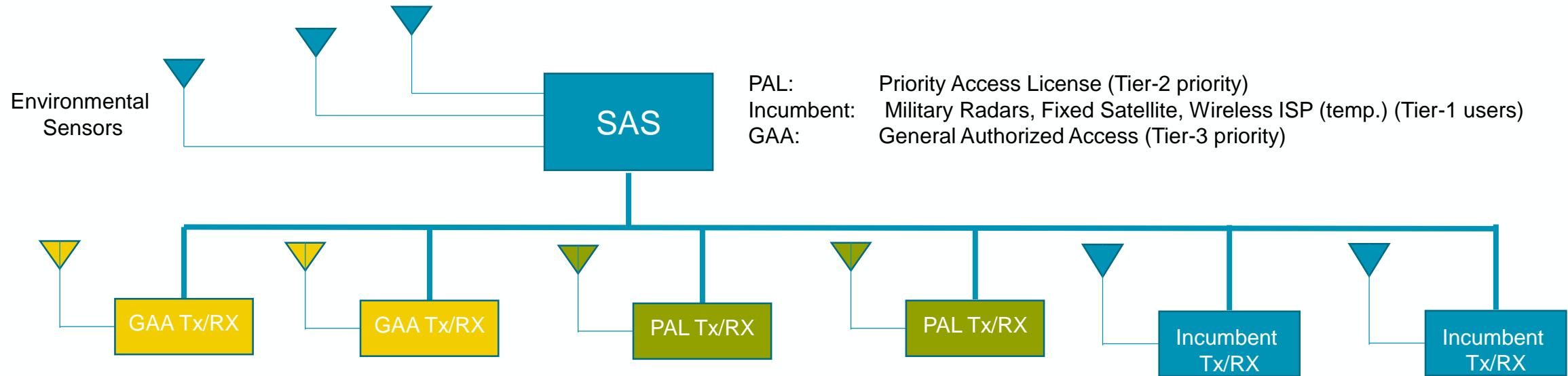

- GAA users are informed by the SAS of the Spectrum Occupancy of higher priority users. Hence, there are no issues in maintaining dynamic spectrum separation.
- GAA users coexist on overlaid basis based on traditional, code-based orthogonality of CDMA

**CDMA-IA would be good air interface for GAA**

## CDMA-IA Key Features

---

- Topology: wireless, ad-hoc mesh (no central controller)
- Shares a common band, say 10 MHz wide, with other independent services employing arbitrary access protocols and spectrum occupancies
- Other networks expected to have higher channel access priority than CDMA-IA
- User traffic is transported by a multiplicity of simultaneous unicast links
- Control information is shared between nodes via unicast or broadcast links
- Duplexing mode: TDD

## Concept of Operations (CONOPS) for CDMA-IA

---

- Each node measures the spectrum occupancy at its location and broadcasts a coded, low-bandwidth description of the spectrum occupancy, called **Spectrum Usability Mask (SUM)**, to all other nodes of the CDMA-IA network.
- **SUM** broadcast is performed using traditional CDMA over the full band
- In the unicast links, each the transmit node's signal's spectrum is shaped to fit into the holes of the **SUM** at the destination node.
  - Referred to as 'water filling' in signal design.
  - Avoids causing interference to other networks and accepting interference from other networks (beyond ss processing gain of CDMA).
- Other innovations
  - Application of Fountain Codes in the frequency domain to excise unusable spectrum segments, as defined in the destination SUM
    - Efficient implementation of spectrum excision while maintaining link communication efficiency
  - In receiver, coherent integration of signal energy over discontinuous segments of spectrum
    - Not done in existing, interference-avoiding spread spectrum systems, such as Bluetooth. Improves communication efficiency.
  - Spectrum spreading is performed using OFDM signals distributed over the spread bandwidth
    - More DSP friendly than direct spreading

# Transmitter Block Diagram

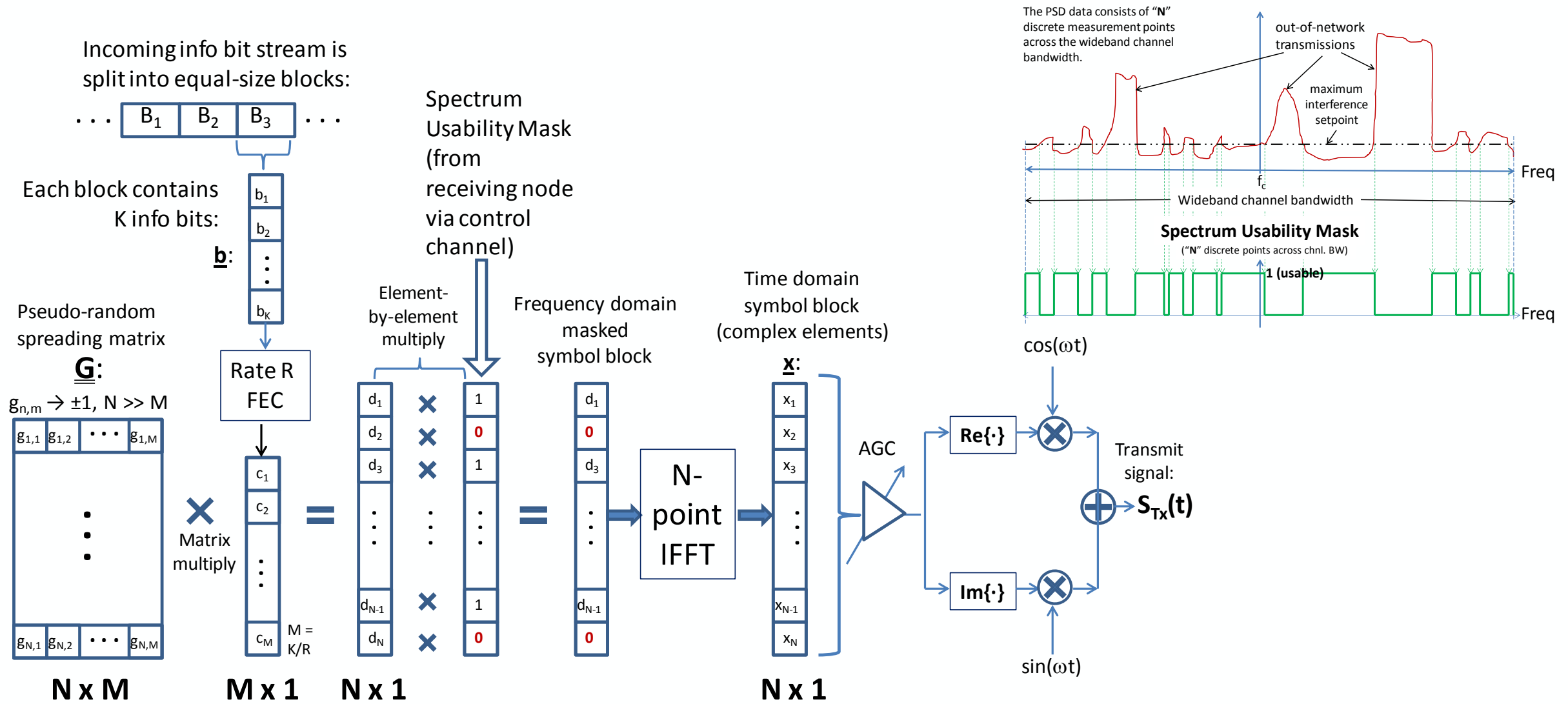



# Receiver Block Diagram

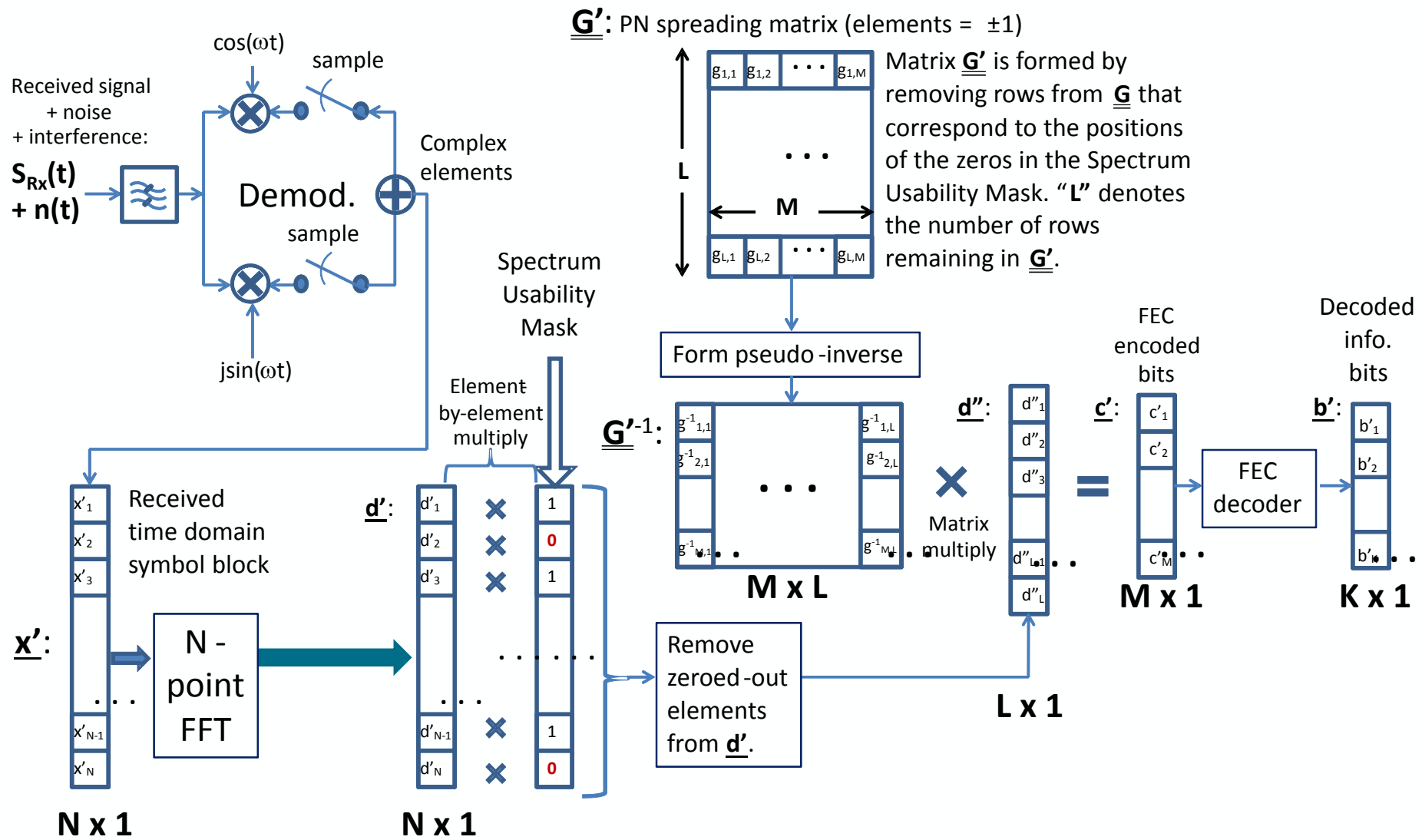

# Simulation Scenario

### Transmit Signal PSD

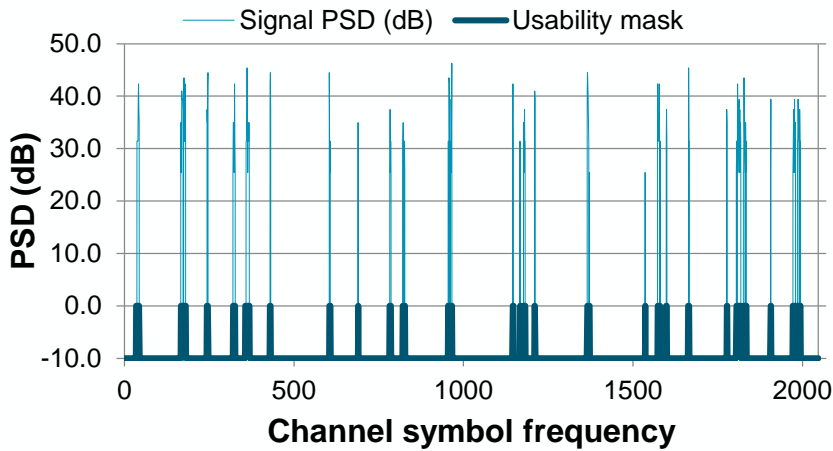

### Transmit Signal Envelope

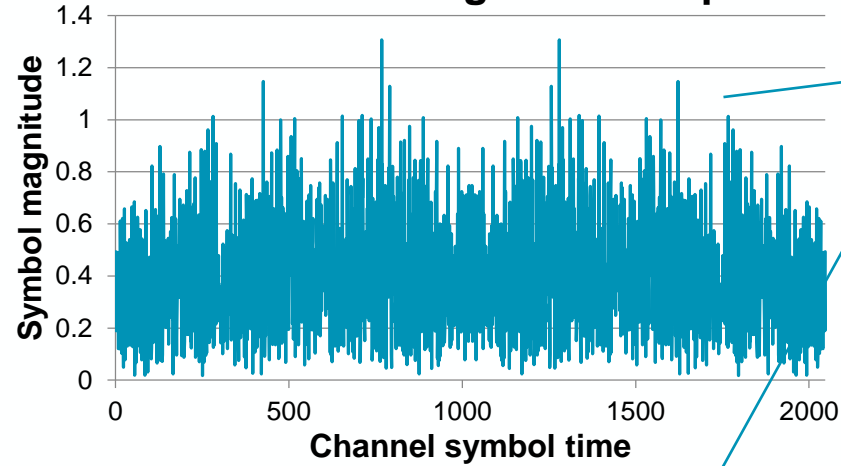

*Note: Tx power is independent of the fraction of the band that is open*

8% of the band is open

### Transmit Signal PSD

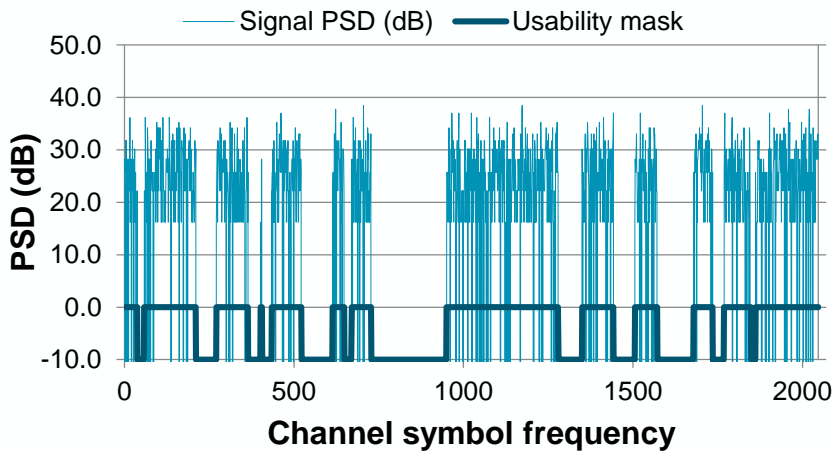

### Transmit Signal Envelope

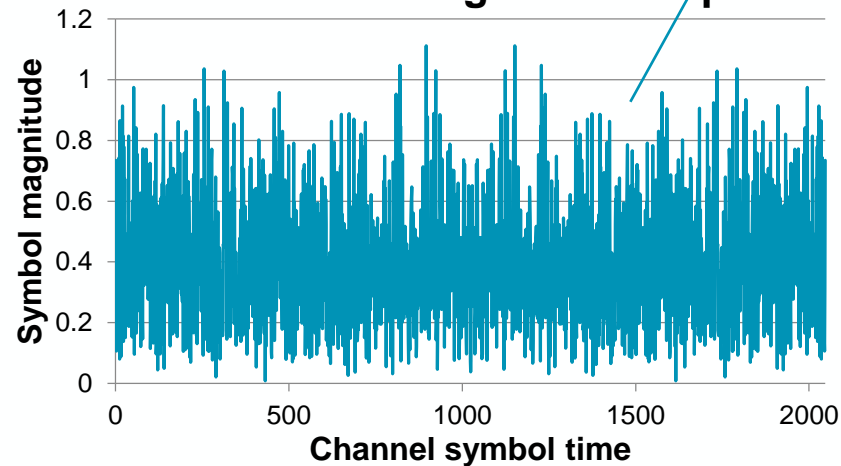

63% of the spectrum open

Plot of Demodulated Data Bit + Noise Amplitude

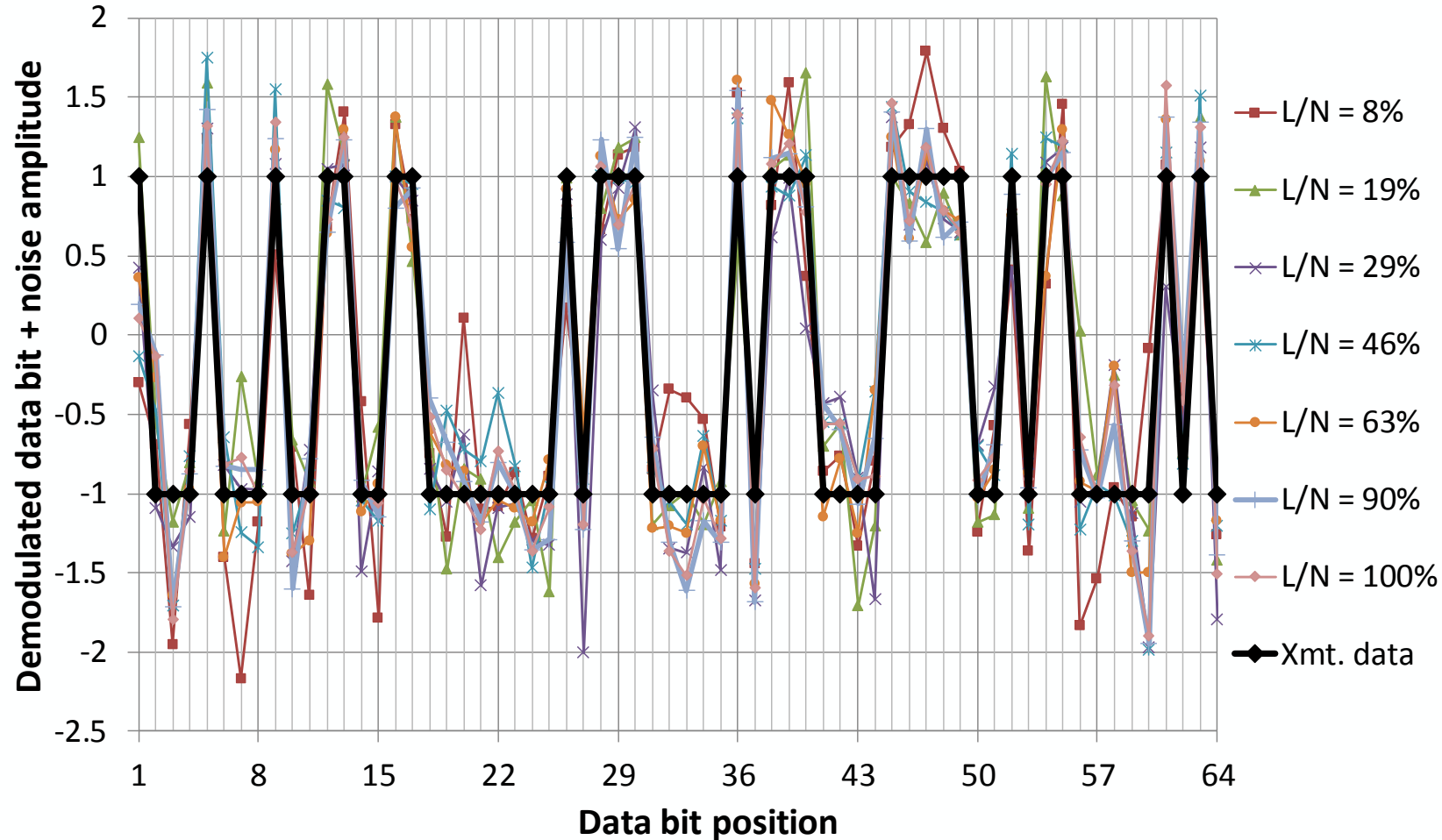

Channel Usability L/N	Demod. Output SNR (dB)	Transmit Signal PAPR (dB)
8%	5.0	9.3
19%	8.8	7.6
29%	7.5	9.1
46%	8.1	7.8
63%	8.8	7.9
90%	8.2	8.7
100%	8.6	8.8

No systematic variation in received SNR with Channel Usability reducing from 100% to 19%

2.3 dB reduction in received SNR with Channel Usability reducing from 100% to 8%

## Potential for AI to improve CDMA-IA (based on literature review [3])

### State of the Art

- Spectrum **Sensing, Decision Making** and **Mobility** take time to execute. We call the net of the above: **Spectrum Adaptation Time**.
- If the **Spectrum Adaptation Time** is long relative to **Spectrum Correlation Time**, then the performance of CDMA-IA may suffer.
- In many practical applications, such as HF and CBRS, this problem does not exist.
  - HF Spectrum Correlation Time often exceeds 30 minutes
  - In CBRS, the SAS informs Spectrum Occupancy in the band to all transmitters
- Nevertheless, we reviewed of AI/Cognitive Radio literature to see if CDMA-IA could be improved. Typical prediction models include
  - Hidden Markov Models
  - Multilayer neural network
  - Bayesian interference-based prediction
  - Moving average model
  - Autoregressive model
  - Static neighbor graph
- An overview of the art is provided in [3].

- ***Dynamic spectrum sharing based on occupancy prediction is still in the Research Phase***
- ***Prediction accuracy may depend on the application***
- ***Does not appear to be ready for mainstream deployment***

### General Conclusion from [1]

**Prediction for spectrum sharing:** To the best of our knowledge, no prediction method for spectrum sharing has been proposed. The difficulty of this research lies in the prediction of CR user activities. Due to the heterogeneous property of CR users and the uncertainty property of CR communications, it is hard to predict the service requests of the CR users in time, space, and frequency domains. Thus, it is difficult to coordinate the spectrum sharing between CR users through prediction.

CR: Cognitive Radio

### CONCLUSION

Spectrum prediction is a promising approach for better realization of cognitive radio functions. Extensive research has been performed on various prediction techniques and applications in CR networks. However, effort is still needed to design prediction-based spectrum sharing methods, provide long-term accurate spectrum prediction, and devise PU activity map prediction schemes.

PU: Primary User

[3] XIAOSHUANG XING, et. al, "Spectrum Prediction in Cognitive Radio Networks", IEEE Wireless Communications, April 2013.

## Summary & Conclusions

---

- CDMA-IA is a decentralized, ad hoc mesh network that can autonomously detect and utilize unused spectrum at a given location, vacating the spectrum when reclaimed by higher priority services. It is suitable for use in highly congested bands.
- CDMA-IA is well suited to applications such as HF and CBRS.
- Unlike traditional CDMA, CDMA-IA avoids overlaying other-network signals, which reduces interference to and from the other-network signals.
  - Suitable when the rules for coexistence with Incumbents are demanding
- Multiple CDMA-IA networks of the same access priority, such as GAA, can share spectrum by leveraging the inherent quasi-orthogonality of CDMA.
  - No special sharing protocol is required.
- MATLAB simulations show
  - No systematic variation in received SNR with Channel Usability reducing from 100% to 19%
  - 2.3 dB reduction in received SNR with Channel Usability reducing from 100% to 8%

## Summary & Conclusions

---

- Applicability of Artificial Intelligence (AI)
  - A literature review has been performed of the potential for using AI to enhance CDMA-IA. Conclusions:
    - Spectrum occupancy prediction based on AI is still in the research phase. General solutions are not available.
    - When robust spectrum occupancy prediction algorithms are developed, CDMA-IA could be coupled to such algorithms
- The innovations in CDMA-IA include
  - Band sharing with other networks based on CDMA with adaptive spectrum excision.
  - Transmit spectrum excision by applying Fountain Codes in the frequency domain.
    - With OFDM as the PHY layer, this approach makes the air interface attractive for DSP-based implementation.
  - Coherently integration of signal energy in the receiver over discontinuous spectrum segments.
    - Improves communication efficiency over existing, interference avoiding spread spectrum techniques, such as Bluetooth.
- Ligado developed CDMA-IA as a PHY/MAC layer for the DARPA SC-2 project.
  - It is supported by link level MATLAB simulations and more documentation about the CONOPS than presented here.
    - See Backup for a more detailed description than the above.
    - A real-time, SDR-based demonstration test bed is under development
- US Patents are pending. Patents will also be filed in many jurisdictions worldwide.

**Ligado is offering the Intellectual Property behind CDMA-IA for licensing**  
**Other implementation assistance can also be provided**

# Backup: Detailed Description

---

## Scenario Definition

SRN: Software Radio Node  
G-SRN: Gateway SRN

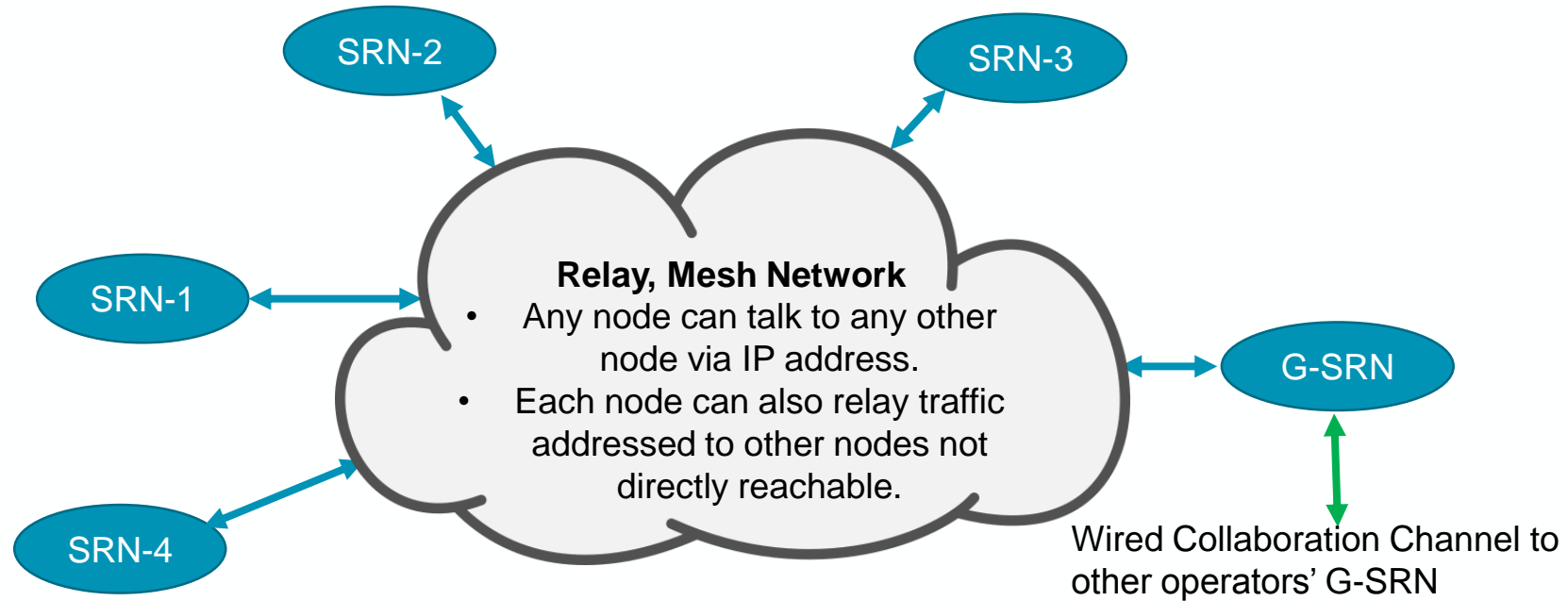

**All wireless networks must share common spectrum via dynamic, self-organizing, unspecified protocols that maximize own and other networks' goodputs**



## Concept of Operations (CONOPS) for CDMA-IA

---

- Each transmitting SRN selects a CDMA waveform whose spectrum occupancy is optimized for the receiving SRN.
  - Air interface fills the holes between transmitted spectra from other users as observed at receiving SRN
  - Referred to as 'water filling' waveform design
  - Avoids causing interference to or receiving interference from other networks sharing the same spectrum block
  - Method recognizes that interference spectra viewed from different SRNs may be different
- The air interface makes dynamic and optimal use of all available unoccupied spectrum
  - Optimizes KPIs of own network, such as packet throughput and latency
- Spectrum adaptation is performed with configurable periodicity, such as every few seconds as the loads on the network are dynamic
- Air Interface is implemented using SDR

## Proposed Enhanced Air Interface Optimized for Congested Channels:

- A synergistic combination of different air interface features that adaptively maximizes channel throughput while avoiding interference to/from other channel users:

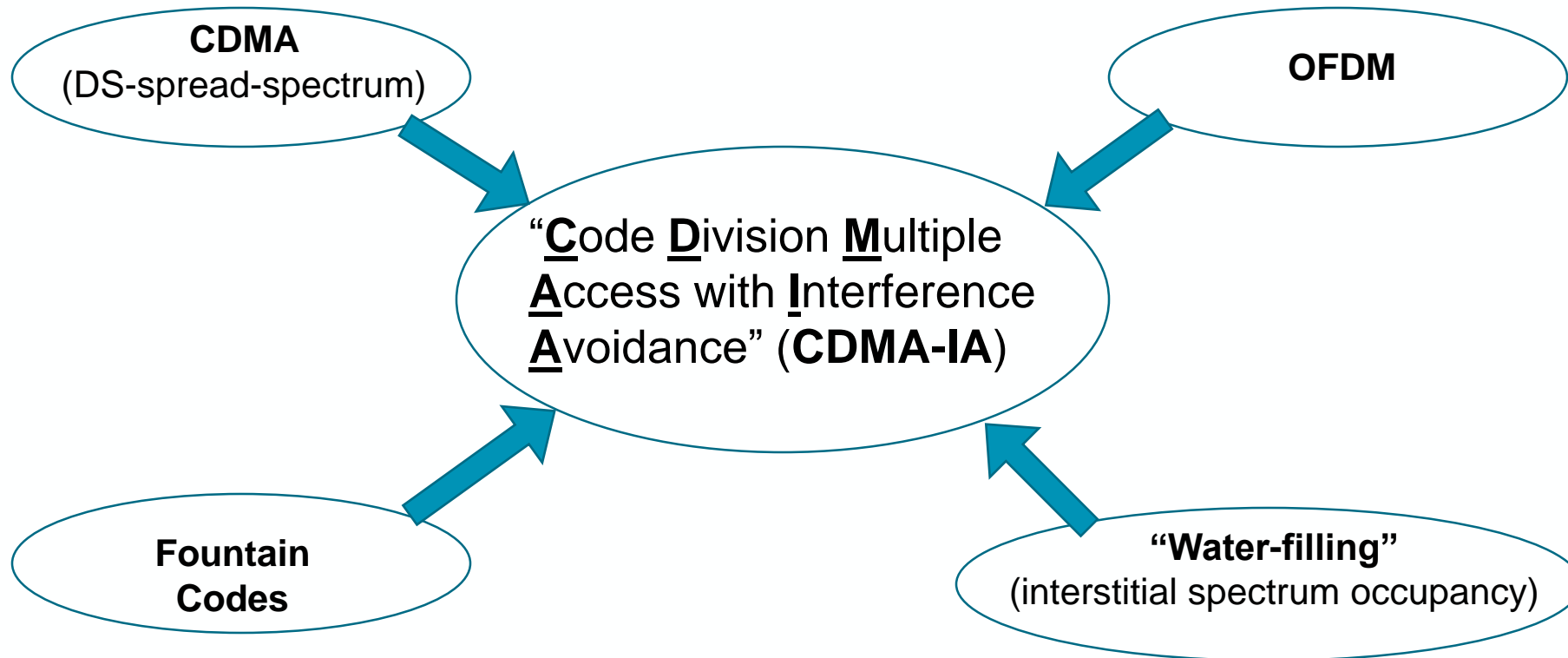

## Air Interface Overview

---

- A proposed enhanced air interface, referred to herein as “Code Division Multiple Access with Interference Avoidance” (CDMA-IA), is described for modulating and coding signal transmissions between radio nodes in a 2-way mesh network operating in a highly congested spectrum environment,
  - The method utilizes a common wideband channel with spectrum spreading to enable frequency-overlaid transmissions.
  - The channel bandwidth may also overlay transmissions from other out-of-network sources (see next slide):
    - Periodic measurements of received interference PSD are made by each network radio node and may be shared with the other nodes over a control channel, to facilitate out-of-network interference avoidance.
    - Carrier frequencies used by other out-of-network sources within the wideband channel are detected and masked-out at transmitter and receiver to minimize interference to/from those sources using an approach similar to water-filling.

## Example of Received RF Interference and Corresponding Spectrum Usability Mask

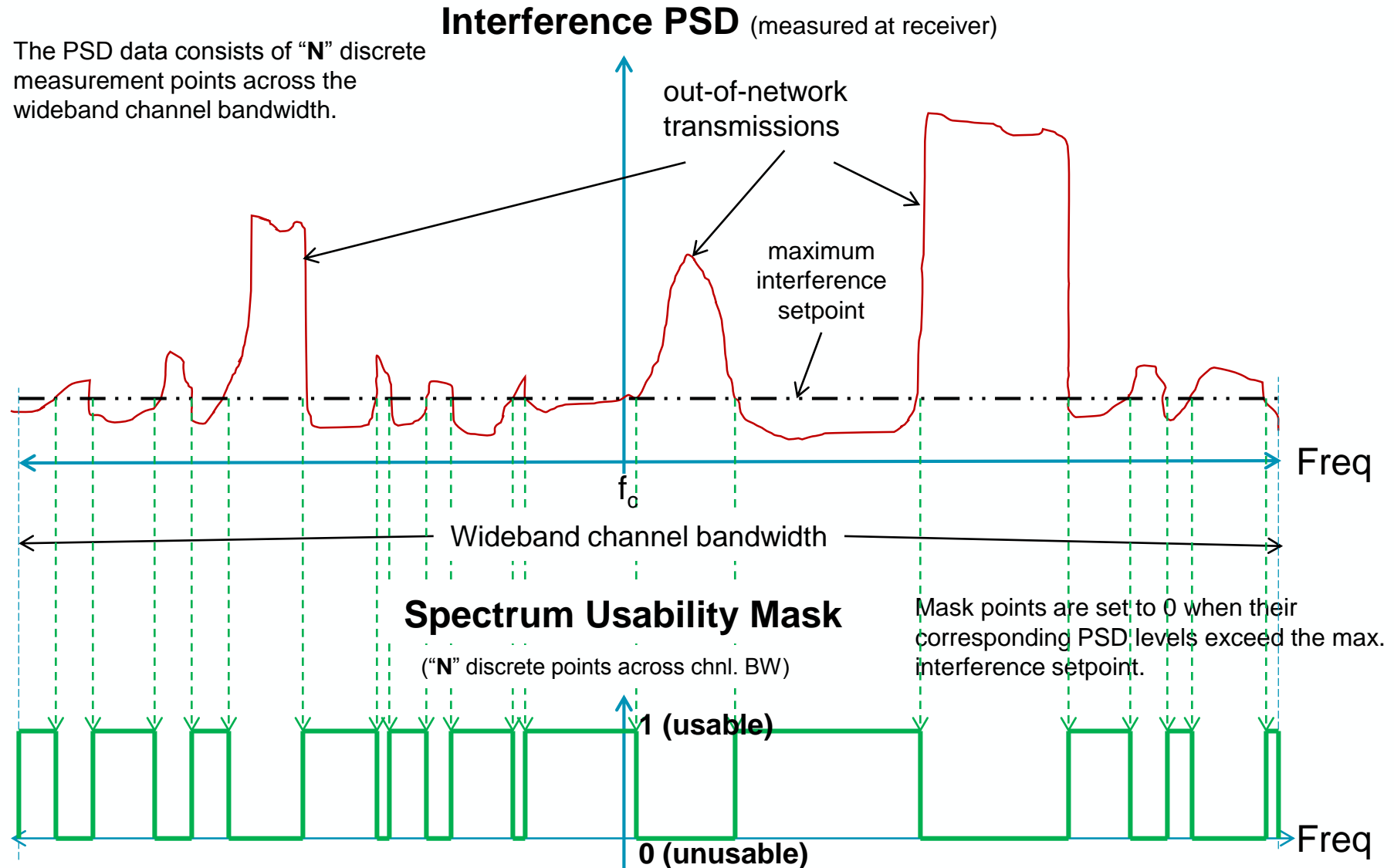



## Transmit-Side Signal Processing Flow (see previous slide)

- Similar to OFDM, transmit symbols are first created in the frequency domain, and then transformed to the time domain using an IFFT. This approach facilitates masking out those frequencies occupied by out-of-network sources using the Spectrum Usability Mask.
- Spectrum spreading is accomplished by matrix-multiplication of the FEC-encoded data bits ( $\pm 1$ ) by a pseudo-random matrix  $\underline{\mathbf{G}}$ , where different uncorrelated PN-sequences are assigned to  $\underline{\mathbf{G}}$  for each transmission channel. The post-spreading block of  $\mathbf{N}$  symbols has the frequency-domain equivalence of spanning the entire wideband channel.
- Matrix multiplication of the data bits by  $\mathbf{G}$  also provides the same code redundancy in the frequency domain that Fountain Codes provide in the time domain. This allows all data bits to be recovered even if some frequencies (corresponding to symbol positions within the block) are zeroed-out by the Spectrum Usability Mask. For example, for a spreading factor of 10, almost 90% of the frequency-domain symbols can be masked out and still recover the entire data block.
- The gain control (AGC) just before the RF modulator is used to equalize the transmitted power as the Spectrum Usability Mask changes. As more spectrum (frequency domain symbols) are zeroed-out by the mask, increased gain is applied to compensate, so that the average transmitted power in the time domain remains constant over all levels of masking.

## CDMA-IA PSD Overlaid on Out-of-Network Carriers (illustration)

- Spectrum shaping effect is similar to water-filling

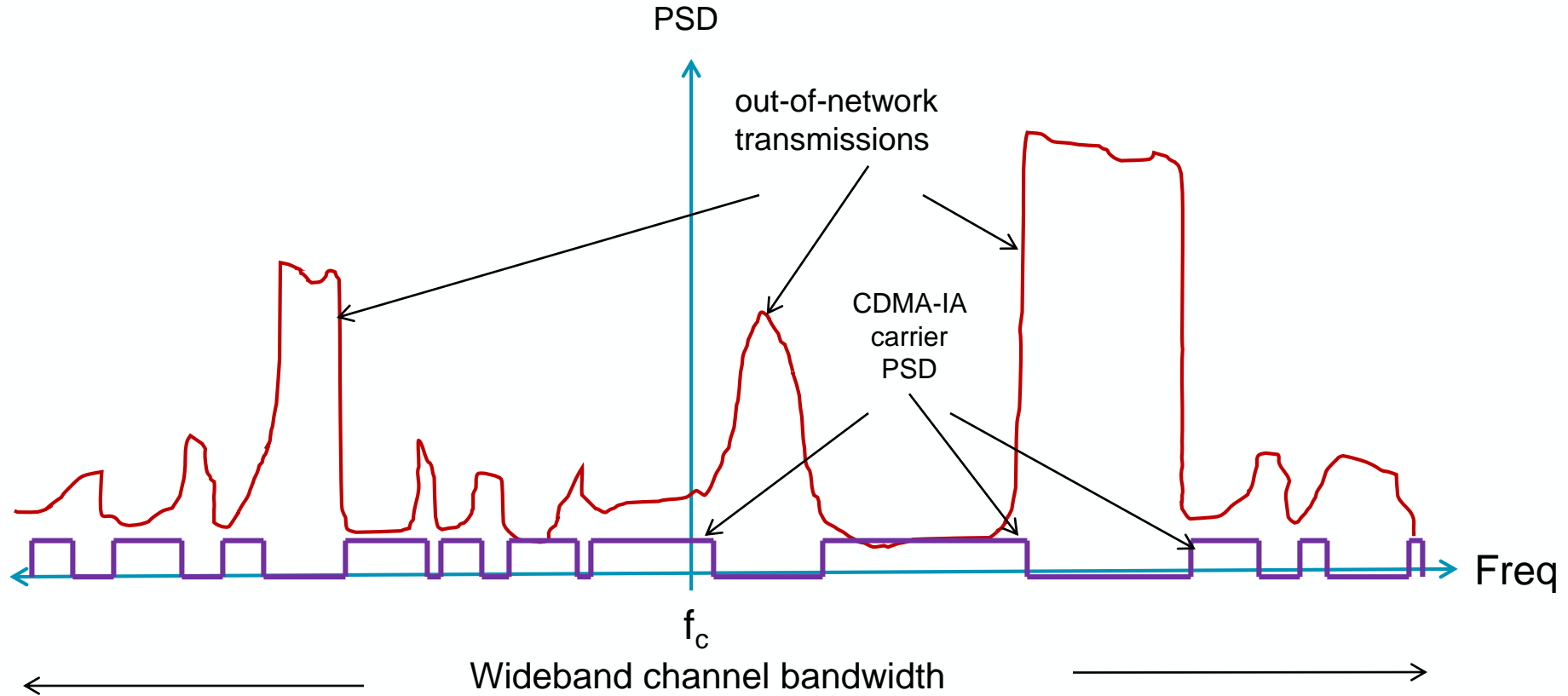

# Signal Processing Block Diagram at Receiver

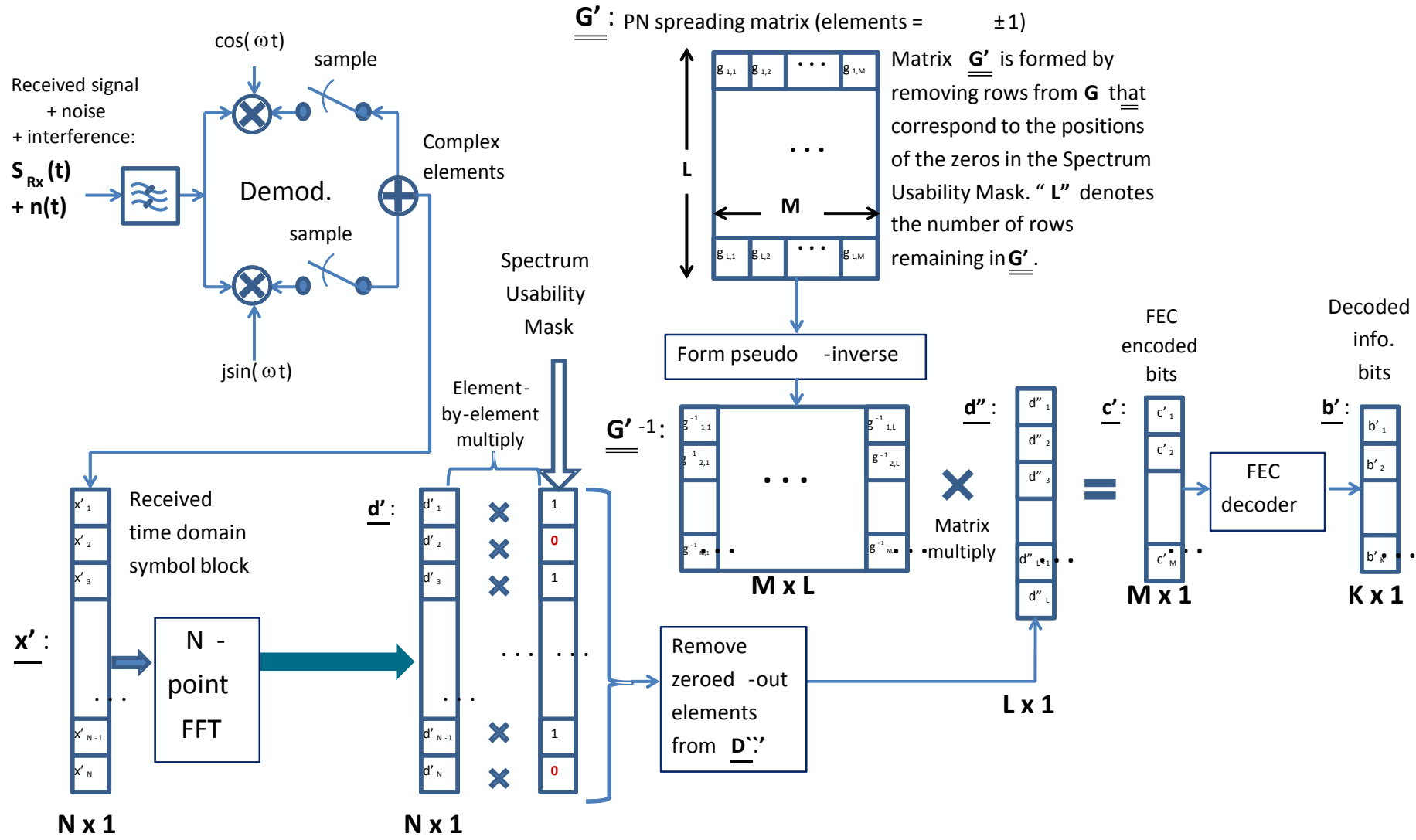



## Proof-of-Concept Simulation #1: Performance versus Channel Spectrum Usability

- Objective: calculate simulated SNR at receiver output as a function of the fraction of usable channel spectrum, while keeping all other link parameters constant:
  - Let “channel usability”  $\equiv L/N$ , ie., the number of usable frequency points (designated by “1”) in the Spectrum Usability Mask divided by the total number of points (2048). All frequency points are uniformly occupied by AWGN. Unusable points (designated by “0”) also contain interference from other carriers (which is removed by the mask along with the noise component).
  - While varying  $L/N$  from 0 to 1, the transmitted CDMA-IA signal power is adjusted to maintain a constant level so that the ratio of signal power to total noise power in the channel equals -10 dB.
  - For each simulated value of  $L/N$ , the SNR at the demodulated receiver output and transmitted signal PAPR are calculated. A single data frame of 64 data bits (2048 spread symbols) is processed for each case.

# Proof-of-Concept Sim. #1: Transmitted CDMA-IA Signal Envelope and PSD

## Case 1: $L/N = 8\%$ Transmit Signal PSD

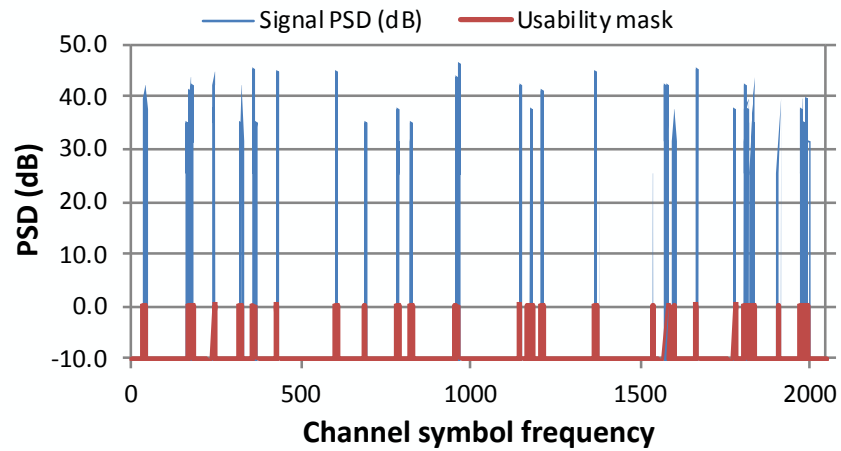

## Transmit Signal Envelope

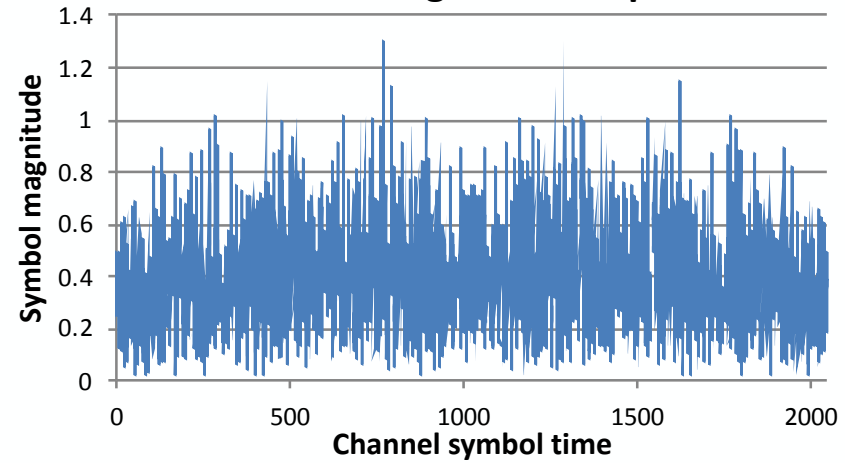

## Case 2: $L/N = 29\%$ Transmit Signal PSD

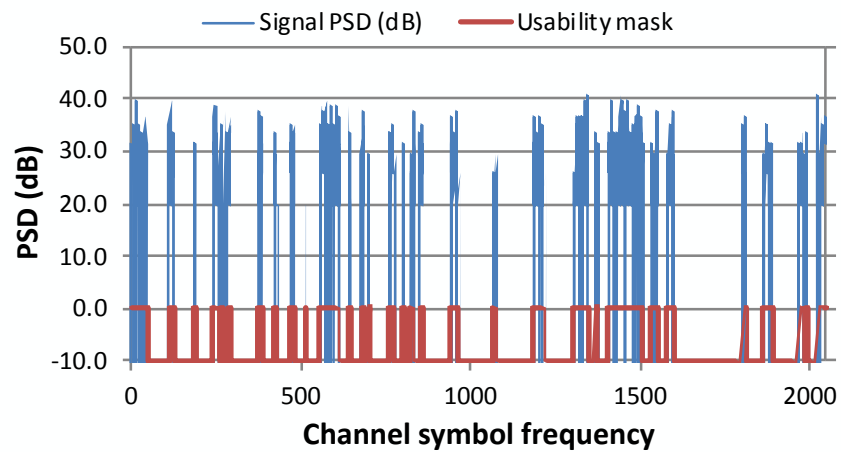

## Transmit Signal Envelope

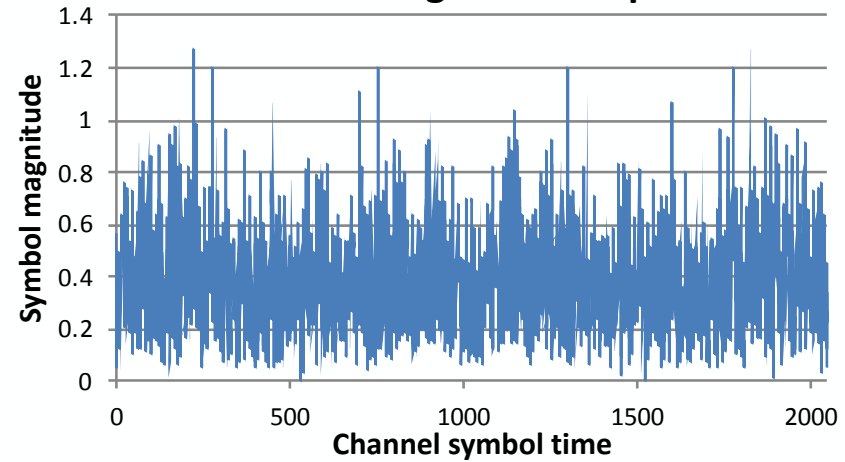

## Proof-of-Concept Sim. #1: Transmitted CDMA-IA Signal Envelope and PSD (cont.)

Case 3:  $L/N = 63\%$  Transmit Signal PSD

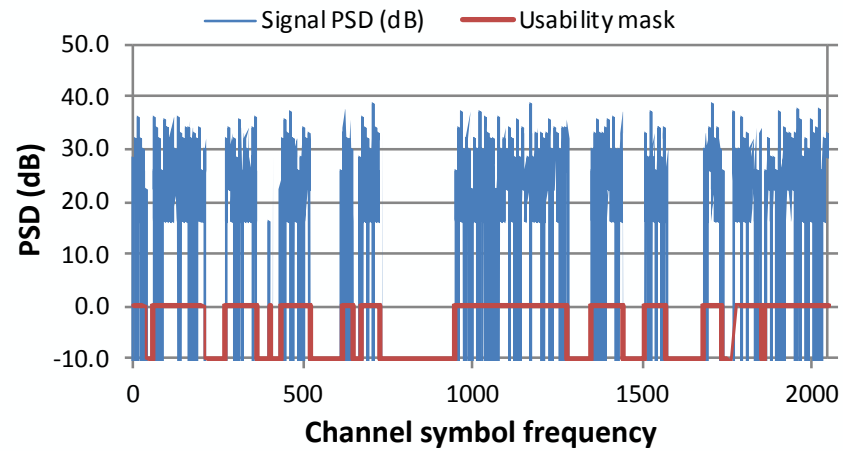

Transmit Signal Envelope

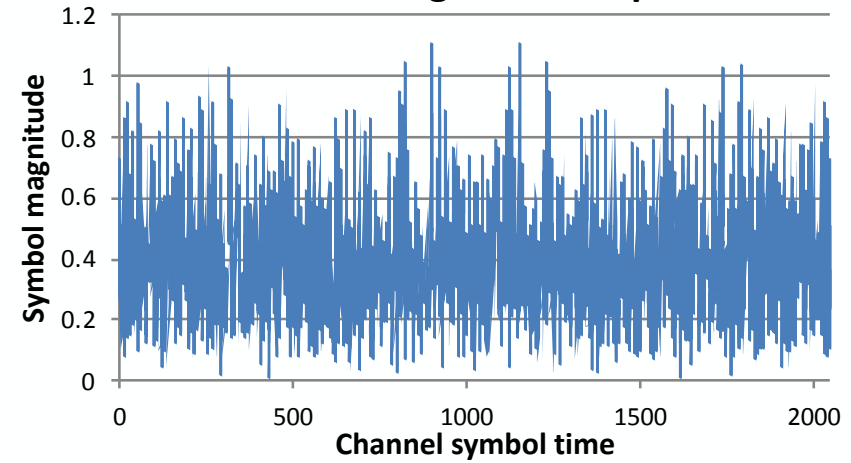

Case 4:  $L/N = 100\%$  Transmit Signal PSD

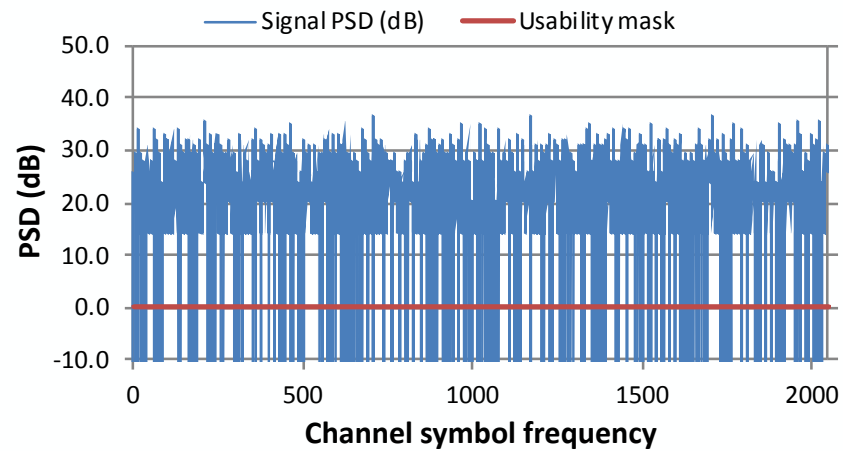

Transmit Signal Envelope

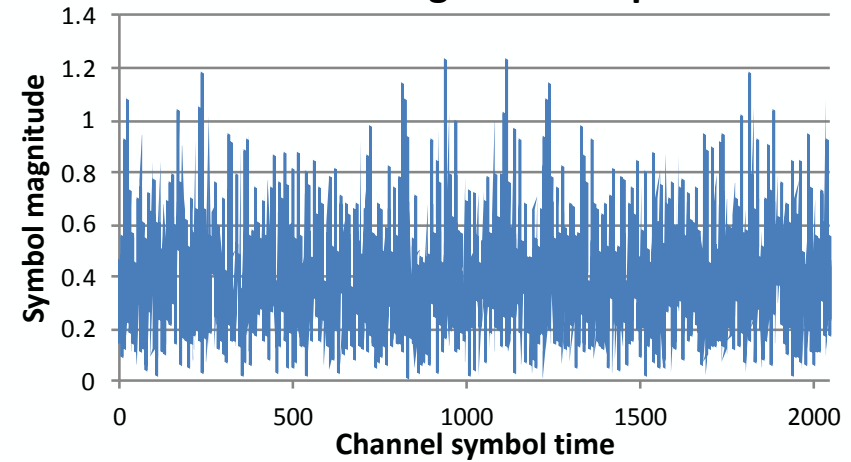

### Plot of Demodulated Data Bit + Noise Amplitude

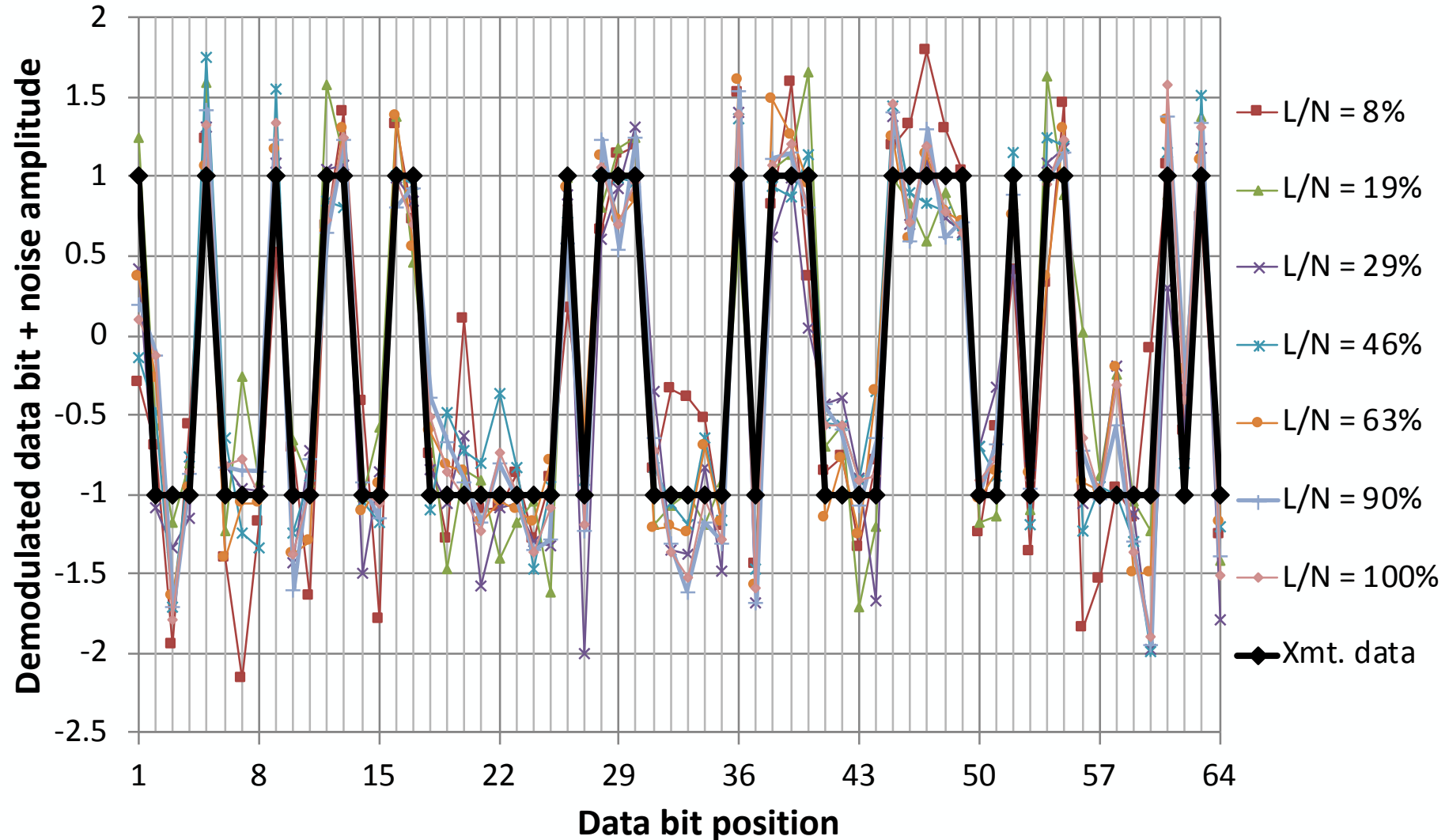

## Proof-of-Concept Sim. #1: Transmit Signal PAPR & Demodulated SNR vs. L/N

Channel Usability L/N	Demod. Output SNR (dB)	Transmit Signal PAPR (dB)
8%	5.0	9.3
19%	8.8	7.6
29%	7.5	9.1
46%	8.1	7.8
63%	8.8	7.9
90%	8.2	8.7
100%	8.6	8.8

## Proof-of-Concept Simulation #2: Compatibility of 2 Overlaid CDMA-IA Signals

---

- In this simulation, two CDMA-IA signals of equal power are transmitted simultaneously over a common channel. Both signals have the same spread-symbol length  $N$ , and number of bits  $K$  per data frame. However the transmitted data bit sequence and spreading matrix  $\mathbf{G}$  differ between the two signals. Therefore, each signal appears as interference at the other's receiver. Signal #1 uses a Spectrum Usability Mask with a channel usability  $L/N = 100\%$  (no unusable frequencies), while Signal #2 uses a different mask having  $L/N = 29\%$ . The frame and symbol timing of the 2 signals are assumed to be aligned. No channel AWGN is added.
- Under these conditions, the SNR at the demodulator output of each receiver is calculated and demodulated data bit + interference levels are plotted.

## Proof-of-Concept Sim. #2: SNR and Data + Interference Levels at Demod. Output

### Signal #1 Demodulator Output: SNR = 16.8 dB

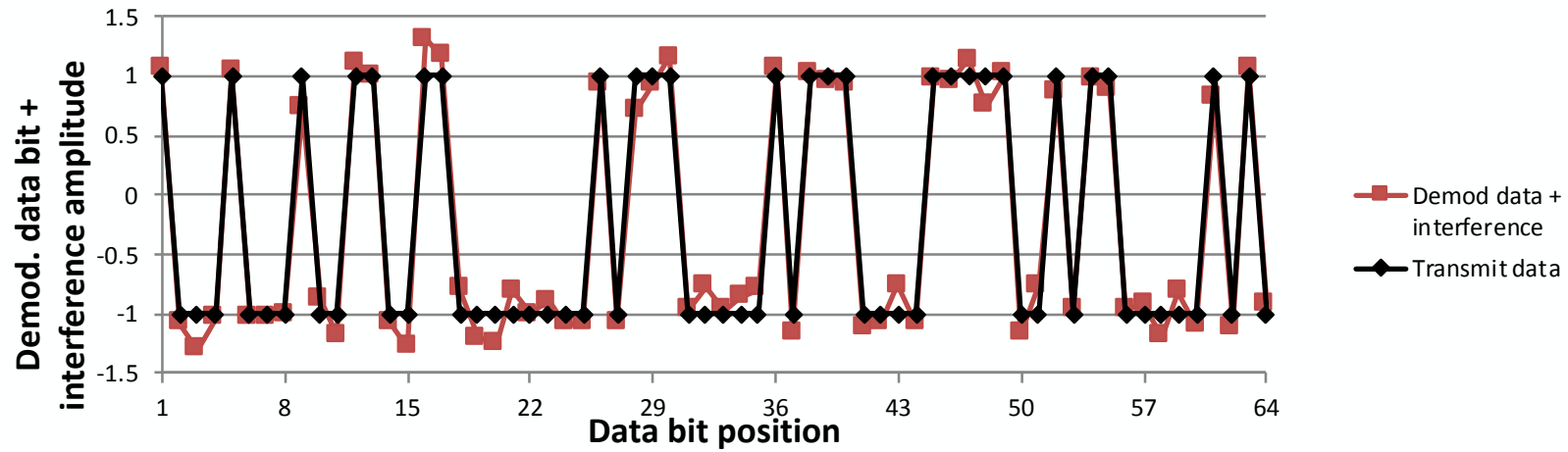

### Signal #2 Demodulator Output: SNR = 14.9 dB

